

ใบเสนอราคา (Quotation)

นามลูกค้า/Customer Name ที่อยู่/Address :  โทรศัพท์/Tel & Fax : TAX ID :	เลขที่เอกสาร/No : วันที่/Date :   E-mail : sy.solare@gmail.com
--------------------------------------------------------------------------------------	----------------------------------------------------------------------------

Item	Description	Qty.	Unit	Unit Price (Baht)	Price Total
<b>A</b>	<b>งานติดตั้งระบบ Solar Cell On Grid 66kW,3Phase</b>	1	Lot	1,590,000.00	1,590,000.00
<b>1</b>	<b>Grid Tie Inverter And Accessories</b>				
	- Huawei Inverter 60KW 3Phase SUN2000-60KTL-M1	1	Set		
	- Smart Power Meter Janizta UMG96RM	1	Set		
	- SmartLogger3000A	2	Set		
<b>2</b>	<b>DC-AC Panel Board</b>				
	- AC Panel Board 60KW	1	Set		
	- Combiner Box Grid Tie PV 8String	1	Set		
	Accessories	1	Lot		
<b>3</b>	<b>Solar panel</b>				
	Solar Cell 550W Mono Half LONGI	116	Ea		
<b>4</b>	<b>Support And Accessories For Solar Panel</b>	<b>1</b>			
	- Rail 4200mm	58	Ea		
	- Mid Clamp Kit 30-35mm.	232	Ea		
	- End Clamp Kit 35mm.	32	Ea		
	- L-Feet	244	Ea		
	- Rail Splice Kit	58	Ea		
	- Grounding Lug	16	Ea		
	- Clip Cable	116	Ea		
	- Grounding Clip	232	Ea		
<b>5</b>	<b>Conduit,Cable And Accessories</b>				
	- PVC Conduit Dia.1/2"	320	m.		
	- PVC Conduit Dia.3/4"	160	m.		
	- Wireway 100x100mm.	20	m.		
	PV Cable				
	- PV-4sq.mm.Red	700	m.		
	- PV-4sq.mm.Black	700	m.		
	IEC-01 Cable				
	- IEC-01 Cable 10q.mm.	20	m.		
	- IEC-01 Cable 50Sq.mm.	80	m.		
<b>6</b>	<b>Grounding System</b>				
	- Ground Rod 5/8x10ft	6	Set		
	- IEC-01 Cable 10q.mm.	60	m.		
	- IEC-01 Cable 35Sq.mm.	40	m.		

เงื่อนไขการรับประกัน :

- 1.ราคาที่เสนอรวมงานทำแบบเพื่อขออนุญาต อ.1
- 2.ราคาที่เสนอรวมงานทำแบบและดำเนินการขออนุญาต กกพ.และขนานไฟฟ้ากับการไฟฟ้าส่วนภูมิภาค
- 3.Inverter รับประกัน 10 ปี
- 4.แผง Solar Cell รับประกัน 12 ปี (ประสิทธิภาพการผลิตพลังงานไฟฟ้าได้ไม่น้อยกว่า80%,25ปี ตามมาตรฐานผลิตภัณฑ์)
- 5.รับประกันงานติดตั้งและอุปกรณ์ไฟฟ้าต่างๆ 3 ปี
- 6.Service ถ้างแผงปีละ 1ครั้งเป็นเวลา 3 ปี

หนึ่งล้านห้าแสนเก้าหมื่นบาทถ้วน

Total Amount 1,590,000.00

Remark : งวดที่1เมื่อตกลงว่าจ้าง ชำระ 10% งวดที่2 เมื่อนำของเข้าหน้างาน ชำระ 30% งวดที่3 หลังจากติดตั้งแล้วเสร็จ พร้อมทดสอบระบบ ชำระ 60%	Special Discount	
	Vat 7%	
	Grand Total	1,590,000.00

\*หลังจากติดตั้งแล้วเสร็จ ดำเนินการขออนุญาตการไฟฟ้าและกกพ 30-45วันทำการ  
หมายเลขบัญชี 109-1-15071-5 ธนาคารกสิกรไทย ชื่อบัญชี บริษัท เอสวายคอนเนค(ประเทศไทย)จำกัด

ผู้อนุมัติชื่อ

ผู้มีอำนาจลงนาม



REQUEST FOR APPROVAL (R.F.A.)

PROJECT : งานติดตั้ง Solar Cell PV Rooftop 60KwP, 3Phase  
 OWNER : \_\_\_\_\_ Ref. No. : SY/...../RFA/MAT/EE/...../65  
 CONTRACTOR : \_\_\_\_\_ No. of Page : \_\_\_\_\_  
 DATE : \_\_\_\_\_ (Including this page)  
 Function :  Main  Elec.  San  Air  
 Lift  Curtain Wall

(1) Contractor's Request Title: **ขออนุมัติใช้วัสดุและอุปกรณ์งานติดตั้ง Solar Cell PV Rooftop 60KwP, 3Phase**

1 Solar PV Inverter On grid Tie	Brand: Hauwei	Model: SUN2000-60KTL-M1
2 Smart Power Meter For Zero Export	Brand: Janizta	Model: Janizta UMG96RM
3 Smart Logger	Brand: Hauwei	Model: SmartLogger3000A01EU
4 Solar Panel	Brand: LONGI	Model: LR4-72HPH-450M/LR5-72HPH-540M
5 PV Cable	Brand: Link	Model: CB-1040X
6 IEC-01 Cable	Brand: BCC	Model: : 450/750V 90 C 60227 IEC-01
7 DC Panel Board	Brand: Local	
8 AC Panel Board	Brand: Local	

**Subject**  Material \_\_\_\_\_ Set  Shop drawing \_\_\_\_\_ Set  
 \_\_\_\_\_ Set  Sample \_\_\_\_\_ Set  Catalog \_\_\_\_\_ 8 Set  
 \_\_\_\_\_ Set  Shop drawing \_\_\_\_\_ Set

**Attached**  Drawing No.: \_\_\_\_\_  
 Specification Ref. No.: \_\_\_\_\_  
 Others: \_\_\_\_\_

**Reference :** \_\_\_\_\_

Remark : \_\_\_\_\_

(2) Attn: Best Medical (Phrae) Limited Parnner From: SY Electric System Limited Partnership  
 For Approval  See note  Acknowledge  
 Note: \_\_\_\_\_  
 \_\_\_\_\_  
 \_\_\_\_\_  
 \_\_\_\_\_

Signature : \_\_\_\_\_  
 ( Mr.Seri Takerngphon )  
 Position : \_\_\_\_\_ Elctrical Engineer  
 Date : \_\_\_\_\_ Time : \_\_\_\_\_

(3) Attn: Designer/Client From: \_\_\_\_\_  
 For Approval  See note  Acknowledge  
 Note: \_\_\_\_\_  
 \_\_\_\_\_  
 \_\_\_\_\_  
 \_\_\_\_\_

Signature : \_\_\_\_\_  
 ( \_\_\_\_\_ )  
 Position : \_\_\_\_\_  
 Date : \_\_\_\_\_ Time : \_\_\_\_\_

(4) Attn: Designer's Result/Comment : From: Designer/Client  
 Approved  Resubmit  
 Approved as note  Not Approved  
 Note: \_\_\_\_\_  
 \_\_\_\_\_  
 \_\_\_\_\_

Signature : \_\_\_\_\_  
 ( \_\_\_\_\_ )  
 Position : \_\_\_\_\_  
 Date : \_\_\_\_\_ Time : \_\_\_\_\_

(5) Attn: Contractor From: \_\_\_\_\_  
 Approved  Resubmit  
 Approved as note  Not Approved  
 Note: \_\_\_\_\_  
 \_\_\_\_\_  
 \_\_\_\_\_

Signature : \_\_\_\_\_  
 ( \_\_\_\_\_ )  
 Position : \_\_\_\_\_  
 Date : \_\_\_\_\_ Time : \_\_\_\_\_

Solar PV Inverter On grid Tie 60kW, 3Phase

Brand : Huawei

Model : SUN2000-60KTL-M1

# Smart String Inverter

SUN2000-60KTL-M0



## Smart

- 12 strings intelligent monitoring and fast trouble-shooting
- Power Line Communication (PLC) supported
- Smart I-V Curve Diagnosis supported

## Efficient

- Max. efficiency 98.9%, European efficiency 98.7% @480 V
- Max. efficiency 98.7%, European efficiency 98.5% @380 V / 400 V
- 6 MPPT per unit, effectively reducing string mismatch

## Safe

- DC switch integrated, safe and convenient for maintenance
- Residual Current Monitoring Unit (RCMU) integrated
- Fuse free design

## Reliable

- Natural cooling technology
- Protection degree of IP65
- Type II surge arresters for both DC and AC

# Smart String Inverter (SUN2000-60KTL-M0)

Technical Specifications	SUN2000-60KTL-M0
<b>Efficiency</b>	
Max. Efficiency	98.9% @480 V, 98.7% @380 V / 400 V
European Efficiency	98.7% @480 V, 98.5% @380 V / 400 V
<b>Input</b>	
Max. Input Voltage	1,100 V
Max. Current per MPPT	22 A
Max. Short Circuit Current per MPPT	30 A
Start Voltage	200 V
MPPT Operating Voltage Range	200 V ~ 1,000 V
Rated Input Voltage	600 V @380 V / 400 V, 720 V @480 V
Number of Inputs	12
Number of MPP Trackers	6
<b>Output</b>	
Rated AC Active Power	60,000 W
Max. AC Apparent Power	66,000 VA
Max. AC Active Power (cosφ=1)	66,000 W
Rated Output Voltage	220 V / 230 V, default 3W + N + PE; 380 V / 400 V / 480 V, 3W + PE
Rated AC Grid Frequency	50 Hz / 60 Hz
Rated Output Current	91.2 A @380 V, 86.7 A @400 V, 72.2 A @480 V
Max. Output Current	100 A @380 V, 95.3 A @400 V, 79.4 A @480 V
Adjustable Power Factor Range	0.8 LG ... 0.8 LD
Max. Total Harmonic Distortion	<3%
<b>Protection</b>	
Input-side Disconnection Device	Yes
Anti-islanding Protection	Yes
AC Overcurrent Protection	Yes
DC Reverse-polarity Protection	Yes
PV-array String Fault Monitoring	Yes
DC Surge Arrester	Type II
AC Surge Arrester	Type II
DC Insulation Resistance Detection	Yes
Residual Current Monitoring Unit	Yes
<b>Communication</b>	
Display	LED Indicators, Bluetooth + APP
RS485	Yes
USB	Yes
Power Line Communication (PLC)	Yes
<b>General</b>	
Dimensions (W x H x D)	1,075 x 555 x 300 mm (42.3 x 21.9 x 11.8 inch)
Weight (with mounting plate)	74 kg (163.1 lb.)
Operating Temperature Range	-25°C ~ 60°C (-13°F ~ 140°F)
Cooling Method	Natural Convection
Max. Operating Altitude	4,000 m (13,123 ft.)
Relative Humidity	0 ~ 100%
DC Connector	Amphenol Helios H4
AC Connector	Cable Gland + OT Terminal
Protection Degree	IP65
Topology	Transformerless
<b>Standard Compliance (more available upon request)</b>	
Certificate	EN 62109-1/-2, IEC 62109-1/-2, EN 50530, IEC 62116, IEC 62910, IEC 60068, IEC 61683
Grid Code	IEC 61727, VDE 4105/0126, UTE C 15-712-1, EN 50438, CLC/TS 50549-1, CEI 0-16/21, C10/11, RD 1699, PO 12.9, PEA, MEA, Philippine Resolution No. 07, AS/NZS 4777.2, DEWA, NRS 097-2-1, IEEE 1547, ABNT

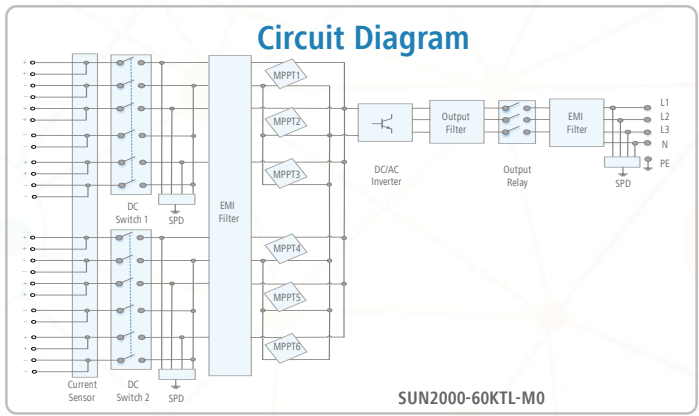
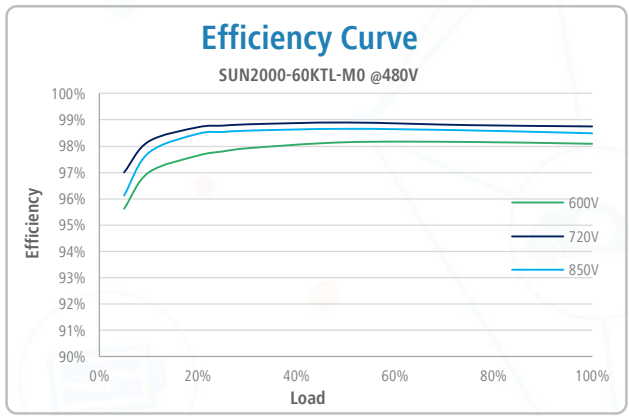

The text and figures reflect the current technical state at the time of printing. Subject to technical changes. Errors and omissions excepted. Huawei assumes no liability for mistakes or printing errors. For more information, please visit solar.huawei.com. Version No.:01-(201812)

## Smart Power Meter For Zero Export

Brand : Janizta

Model : Janizta UMG96RM



UMG 96RM – Multifunction power analyser

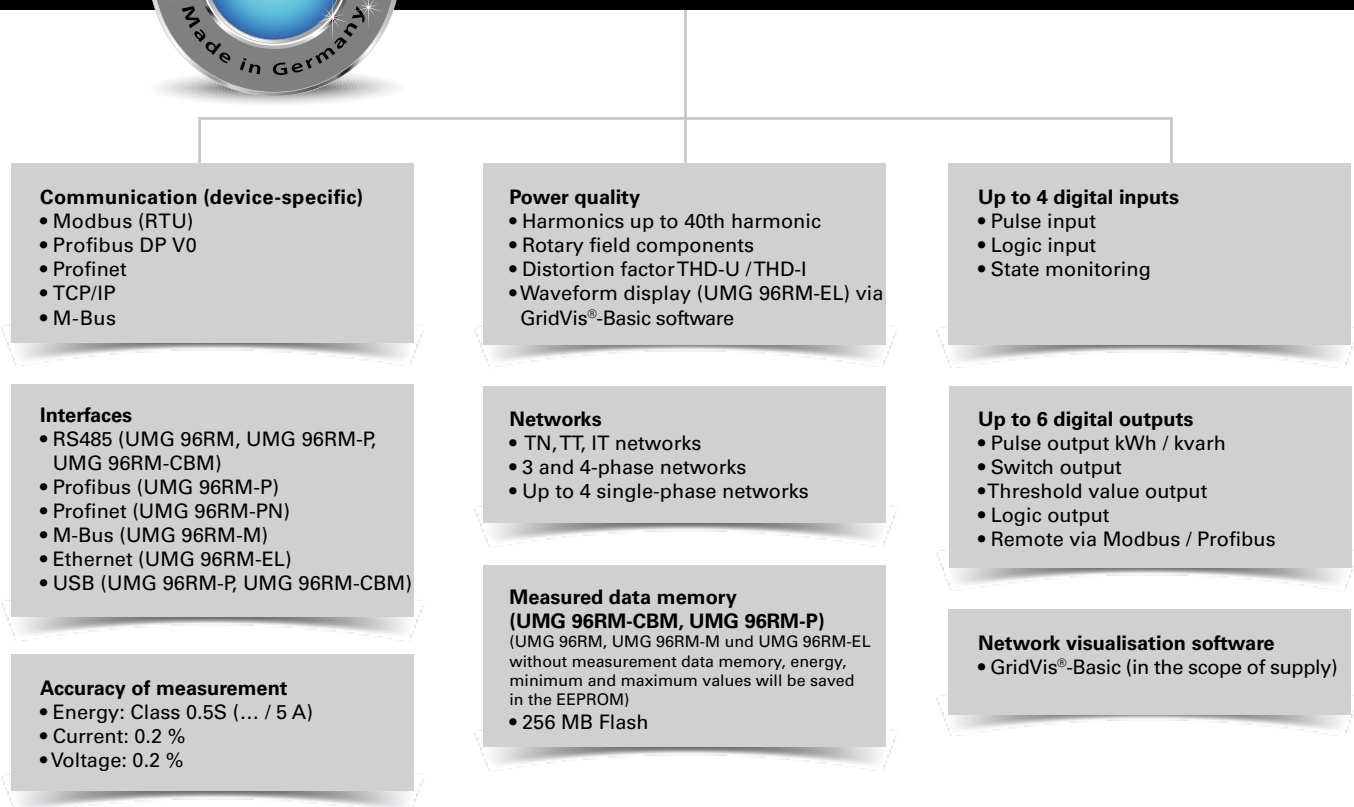



## Areas of application



- Measurement, monitoring and checking of electrical characteristics in energy distribution systems
- Recording of load profiles for energy management systems (e.g. ISO 50001)
- Acquisition of the energy consumption for cost centre analysis
- Measured value transducer for building management systems or PLC (Modbus)

## Main features

### Particular advantages

- Compact construction saves space and costs during installation
- Seamless and sustained recording thanks to large measured data memory or via the online data acquisition (e.g. GridVis®-Service)
- High data security and redundancy
- Comprehensive communications options and protocols
- Multifaceted, pre-defined reports for power quality and energy consumption analysis (via GridVis®-Service)
- Simple report generation at the press of a button or automatically in accordance with defined time plans
- Precision measurement results provide an effective infrastructure as well as high production availability
- Generic Modbus profile: Arbitrary Modbus-capable devices and systems from other manufacturers can be incorporated and visualised in the monitoring solutions
- Long-term availability of the measurement devices guarantees simple retrofitting with system expansions

### Energy data acquisition & load profile

- Detailed acquisition of the energy data and the load profile
- More transparency in energy supply through energy analyses
- Safer design of the power distribution systems

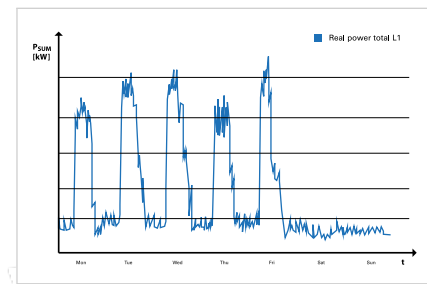

Fig.: Load profiles are the basis for energy management



**Cost centre analysis**

- Determination of energy costs
- Breakdown and allocation of energy consumers

**Energy management systems (ISO 50001)**

- Continuous increase in energy efficiency
- Cost reduction
- UMG 96RM series multifunctional power analysers are an important part of energy management systems

**Transparency of energy supply**

- More transparency through a multi-stage, scalable measurement system
- Acquisition of individual events through continuous measurement with high resolution

	January	February	March	April	December	Total
HICA Water Boiler Heating	2480 12 kWh	1240 6 kWh	160 0,8 kWh	380 1,9 kWh	240 1,2 kWh	4500 € 21,9 kWh
HICA Water Total	737 3,7 m <sup>3</sup>	386 1,9 m <sup>3</sup>	790 3,9 m <sup>3</sup>	506 2,5 m <sup>3</sup>	454 2,3 m <sup>3</sup>	2873 € 14,3 m <sup>3</sup>
Hall 1 Final assembly	166 831 kWh	155 776 kWh	183 920 kWh	174 871 kWh	171 856 kWh	849 € 4254 kWh
Hall 2 Painting	155 776 kWh	171 856 kWh	166 831 kWh	195 980 kWh	191 956 kWh	878 € 4399 kWh
<b>Total</b>	<b>3538 €</b>	<b>1952 €</b>	<b>1299 €</b>	<b>1255 €</b>	<b>1056 €</b>	<b>9100 €</b>

Fig.: Cost centre analysis

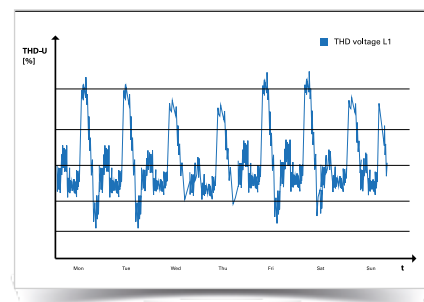

Fig.: Transparency of energy supply



**Power quality monitoring**

- Notification of inadequate power quality
- Introduction of measures to address network problems
- Prevention of production downtimes
- Significantly longer service life for equipment
- Improved sustainability



**Measurement accuracy of 0.2 % (V), kWh class = 0.5S**

- High sampling rate at 21.3 kHz
- Reliable measurement accuracy of 0.2 % (V)
- Effective energy class (kWh): 0.5S



**Energy meter with 8 tariffs, effective and reactive energy**

- Energy measurement in 4 quadrants, each with 8 tariffs for effective and reactive energy
- Safe and precise acquisition of operational values for individual electrical loads



**Communications options: Ethernet, Profibus, Modbus, M-Bus, ...**

- Numerous interfaces and protocols, guaranteeing an easy system connection (energy management system, PLC, SCADA, BMS)

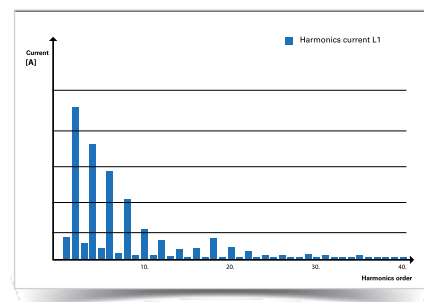

Fig.: Power quality monitoring (Harmonics analysis for the current up to 40th order harmonics)



**Large measurement data memory**

- Saving of measurement data possible over very long periods of time
- Recording freely user configurable



**Harmonics analyser**

- Harmonics analysis up to 40th harmonic
- Information about power quality, grid disturbances and possible "network polluters"

**Pluggable screw terminals**

- Convenient installation even where spaces are tight

**Backlight**

- Large, high-contrast LCD display with backlighting
- Very good readability and intuitive operation, even in poor lighting conditions

**Basic device**

- RS485 interface with Modbus protocol and 2 digital outputs enable quick and low-cost monitoring of power quality and energy consumption

**Profibus and digital IOs**

- The Profibus connection is used in systems where the UMG 96RM-P is to be incorporated into the automation environment (PLC controllers)



**M-Bus**

- The UMG 96RM-M can be simply and cost-effectively integrated into consumption data acquisition systems via the M-Bus connection.
- The M-Bus is primarily used for the acquisition of consumption data collection from various different consumption meters, such as water, gas, heat or electrical current.

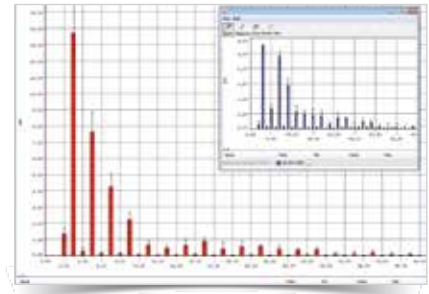

Fig.: GridVis® software: Harmonics analysis



Fig.: Pluggable screw terminals for easy connection



Fig.: LCD Display backlight



**Ethernet (TCP/IP) with the UMG 96RM-EL**

- Simple integration into the Ethernet (LAN) network
- Fast and reliable data communication

**4th current transformer input**

- Continuous monitoring of the N-conductor by means of the 4th current input
- Available with variants UMG 96RM-P and UMG 96RM-CBM



**Dimension diagrams**

All dimensions in mm

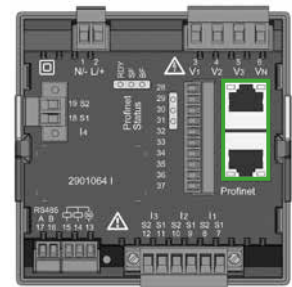
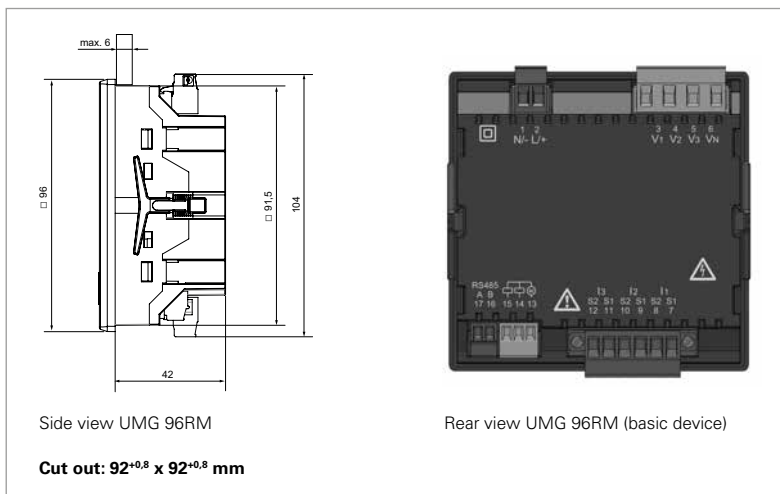

Rear view UMG 96RM-PN Profinet variant

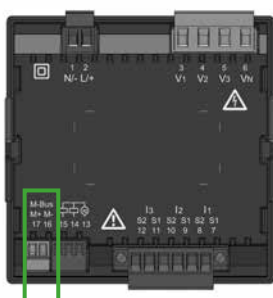

Rear view 96RM-M M-Bus variant

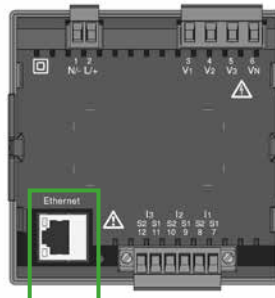

Rear view 96RM-EL Ethernet light variant

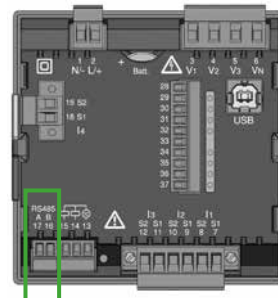

Rear view 96RM-CBM Modbus variant

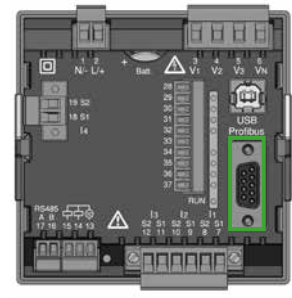

Rear view 96RM-P Profibus variant

The illustrations shown here are examples. Further dimensional drawings and connection diagrams are available on request or can be viewed on our homepage.



## Typical connection

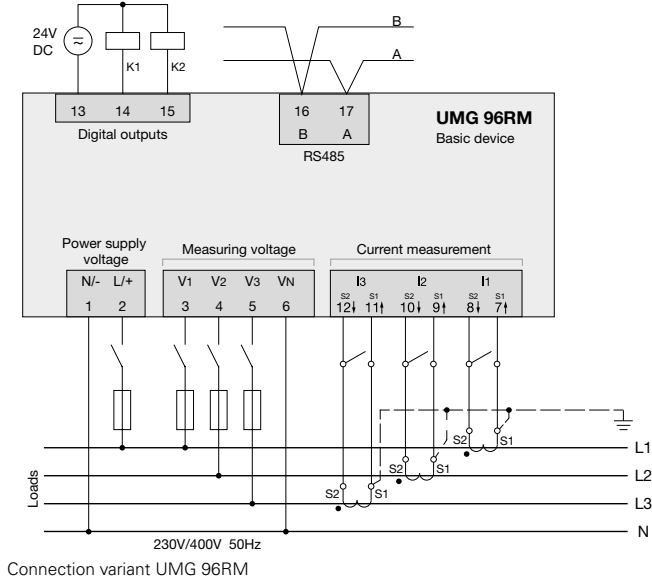

The illustration shown here is an example. Further connection diagrams are available on request or can be viewed on our homepage.



## Device overview and technical data

	UMG 96RM*1	UMG 96RM-M*1	UMG 96RM-EL*1	UMG 96RM-CBM*1	UMG 96RM-P*1	UMG 96RM-PN*1
Item no. (90–277 V AC/90–250 V DC)	52.22.061	52.22.069	52.22.068	52.22.066	52.22.064	52.22.090
Item no. (24–90 V AC/24–90 V DC)	52.22.070	52.22.073	52.22.072	52.22.067	52.22.065	52.22.091
Interfaces	RS485	M-Bus	Ethernet	RS485, USB	RS485, Profibus, USB	RS485, Ethernet, Profinet
Protocols						
Modbus RTU	•	-	-	•	•	•
Modbus TCP	-	-	•	-	-	•
Profibus DP V0	-	-	-	-	•	-
Profinet	-	-	-	-	-	•
M-Bus	-	•	-	-	-	-
DHCP oder DCP	-	-	•	-	-	•
ICMP (Ping)	-	-	•	-	-	•
Measured data recording						
Current measurement channel	3	3	3	4	4	4 (+2)
Memory (Flash)	-	-	-	256 MB	256 MB	-
Battery	-	-	-	Type CR2032 3 V, Li-Mn	Type CR2032 3 V, Li-Mn	-
Clock	-	-	-	•	•	-
Digital inputs and outputs						
Digital inputs	-	-	-	4	4	3 <sup>3</sup>
Digital outputs (as switch or pulse output)	2	2	-	6	6	2 (+3) <sup>3</sup>
Mechanical properties						
Device dimensions in mm (H x W x D) <sup>2</sup>	96 x 96 x approx. 48	96 x 96 x approx. 48	96 x 96 x approx. 48	96 x 96 x approx. 78	96 x 96 x approx. 78	96 x 96 x approx. 78

Comment: For detailed technical information please refer to the operation manual and the Modbus address list.

• = included - = not included

\*1 Inclusive UL certification.

\*2 Accurate device dimensions can be found in the operation manual.

\*3 Optionally 3 digital inputs or outputs (no pulse output)

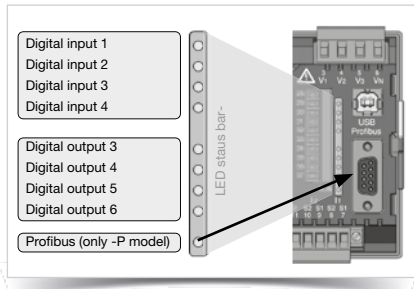

Fig.: LED status bar for the inputs and outputs (UMG 96RM-CBM and UMG 96RM-P)



Fig.: UMG 96RM-PN with Profinet interface



Fig.: Battery insertion on the rear (UMG 96RM-CBM and UMG 96RM-P)

General	
Use in low and medium voltage networks	•
Accuracy voltage measurement	0.2 %
Accuracy current measurement	0.2 %
Accuracy active energy (kWh, .../5 A)	Class 0.5S
Number of measurement points per period	426
Uninterrupted measurement	•
RMS - momentary value	
Current, voltage, frequency	•
Active, reactive and apparent power / total and per phase	•
Power factor / total and per phase	•
Energy measurement	
Active, reactive and apparent energy [L1,L2,L3, Σ L1-L3]	•
Number of tariffs	14
Recording of the mean values	
Voltage, current / actual and maximum	•
Active, reactive and apparent power / actual and maximum	•
Frequency / actual and maximum	•
Demand calculation mode (bi-metallic function) / thermal	•
Other measurements	
Operating hours measurement	•
Power quality measurements	
Harmonics per order / current and voltage	1st – 40th
Distortion factor THD-U in %	•
Distortion factor THD-I in %	•
Rotary field indication	•
Current and voltage, positive, zero and negative sequence component	•
Measured data recording	
Average, minimum, maximum values	•
Alarm messages	•
Time stamp	•
Time basis average value	freely user-defined
RMS averaging, arithmetic	•
Displays and inputs / outputs	
LCD display (with backlighting), 2 buttons	•
Voltage inputs	L1, L2, L3 + N
Password protection	•
Software GridVis®-Basic**	
Online and historic graphs	•
Databases (Janitza DB, Derby DB); MySQL, MS SQL with higher GridVis® versions)	•
Manual reports (energy, power quality)	•
Topology views	•
Manual read-out of the measuring devices	•
Graph sets	•
Programming / threshold values / alarm management	
Comparator (2 Groups with 3 comparators each)	•
Technical data	
Type of measurement	Constant true RMS Up to 40th harmonic
Nominal voltage, three-phase, 4-conductor (LN, LL)	277 / 480 V AC
Nominal voltage, three-phase, 3-conductor (L-L)	480 V AC
Measurement in quadrants	4
Networks	TN, TT, IT

Comment:  
For detailed technical information please refer to the operation manual and the Modbus address list.

• = included - = not included

\*\* Optional additional functions with the packages GridVis®-Professional, GridVis®-Service and GridVis®-Ultimate.

<b>Measured voltage input</b>	
Overvoltage category	300 V CAT III
Measured range, voltage L-N, AC (without potential transformer)	10 ... 300 Vrms
Measured range, voltage L-L, AC (without potential transformer)	18 ... 520 Vrms
Resolution	0.01 V
Impedance	4 MOhm / phase
Frequency measuring range	45 ... 65 Hz
Power consumption	approx. 0.1 VA
Sampling frequency per channel (50 / 60 Hz)	21.33 / 25.6 kHz
<b>Measured current input</b>	
Rated current	1 / 5 A
Resolution	0.1 mA
Measurement range	0.001 ... 6 Amps
Overvoltage category	300 V CAT II
Measurement surge voltage	2 kV
Power consumption	approx. 0.2 VA (Ri = 5 mOhm)
Overload for 1 sec.	120 A (sinusoidal)
Sampling frequency per channel (50 / 60 Hz)	21.33 / 25.6 kHz
<b>Digital inputs and outputs</b>	
<b>Digital inputs<sup>*5</sup></b>	
Maximum counting frequency	20 Hz
Input signal present	18 ... 28 V DC (typical 4 mA)
Input signal not present	0 ... 5 V DC, current < 0.5 mA
<b>Digital outputs<sup>*6</sup></b>	
Switching voltage	max. 60 V DC, 33 V AC
Switching current	max. 50 mA Eff AC / DC
Response time	10 / 12 periods + 10 ms
Pulse output (energy pulse)	max. 50 Hz
Maximum cable length	up to 30 m unscreened, from 30 m screened
<b>Mechanical properties</b>	
Weight	approx. 0.3 kg
Protection class per EN 60529	Front: IP40; Back: IP20
Assembly per IEC EN 60999-1 / DIN EN 50022	Front panel installation
<b>Cable cross section</b>	
Supply voltage	0.2 to 2.5 mm <sup>2</sup>
Current measurement	0.2 to 2.5 mm <sup>2</sup>
Voltage measurement	0.08 to 4.0 mm <sup>2</sup>
<b>Environmental conditions</b>	
Temperature range	Operation: K55 (-25 ... +70 °C)
Relative humidity	Operation: 0 to 90 % RH
Operating height	0 ... 2000 m above sea level
Degree of pollution	2
Installation position	user-defined
<b>Electromagnetic compatibility</b>	
Electromagnetic compatibility of electrical equipment	Directive 2004/108/EC
Electrical equipment for use within certain voltage limits	Directive 2006/95/EC
<b>Equipment safety</b>	
Safety requirements for electrical equipment for measurement, regulation, control and laboratory use – Part 1: General requirements	IEC/EN 61010-1
Part 2-030: Particular requirements for testing and measuring circuits	IEC/EN 61010-2-030
<b>Noise immunity</b>	
Class A: Industrial environment <sup>*7</sup>	IEC/EN 61326-1
Electrostatic discharge	IEC/EN 61000-4-2
Voltage dips	IEC/EN 61000-4-11
<b>Emissions</b>	
Class B: Residential environment	IEC/EN 61326-1
Radio disturbanc voltage strength 30 – 1000 MHz	IEC/CISPR11/EN 55011
Radiated interference voltage 0.15 – 30 MHz	IEC/CISPR11/EN 55011
<b>Firmware</b>	
Firmware update	Update via GridVis <sup>®</sup> software. Firmware download (free of charge) from the website: <a href="http://www.janitza.com/downloads">http://www.janitza.com/downloads</a>

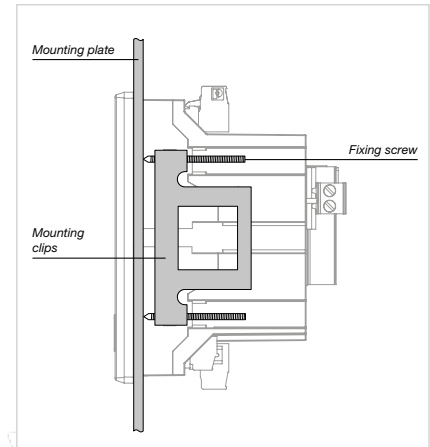

Fig.: The fastening into a switchboard is implemented via the side-mounted fastening clamps (UMG 96RM-P / UMG 96RM-CBM)

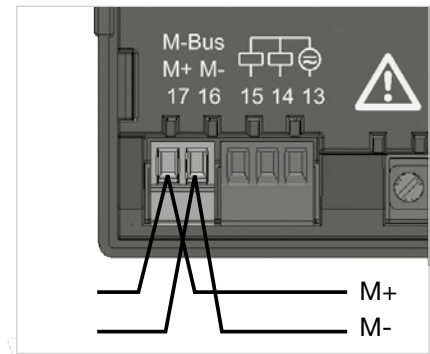

Fig.: M-Bus interface with 2-pole plug contact

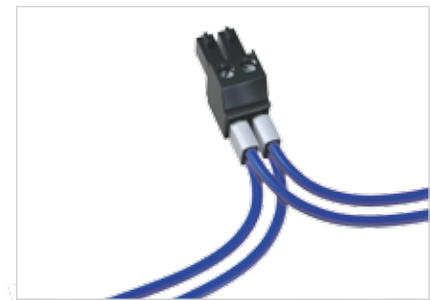

Fig.: 2-pole plug contact with cable connection (cable type: 2 x 0.75 mm<sup>2</sup>) via twin core end sheaths

Comment: For detailed technical information please refer to the operation manual and the Modbus address list

• = included - = not included

<sup>\*5</sup> The information relates exclusively to the measurement devices UMG 96RM-CBM, UMG 96RM-P and UMG 96RM-PN.

<sup>\*6</sup> The information relates exclusively to the measurement devices UMG 96RM, UMG 96RM-M, UMG 96RM-CBM, UMG 96RM-P and UMG 96RM-PN.

<sup>\*7</sup> UMG 96RM-PN exclusive Class A: Industrial environment

## Smart Logger

Brand : Huawei

Model : SmartLogger3000A01EU



### Smart

Smart zero export control design



### Simple

Easy to install on site



### Reliable

Safety by lightning protection module

Technical Specification	SmartLogger3000A01EU
<b>Device Management</b>	
Max. Number of Manageable Devices <sup>3</sup>	80
<b>Communication Interface</b>	
WAN	WAN x 1, 10 / 100 / 1000 Mbps
LAN	LAN x 1, 10 / 100 / 1000 Mbps
RS485	COM x 3, 1200 / 2400 / 4800 / 9600 / 19200 / 115200 bps, 1000 m
2G / 3G / 4G <sup>1</sup>	LTE(FDD) : B1,B2,B3,B4,B5,B7,B8,B20 DC-HSPA+/HSPA+/HSPA/UMTS : 850/900/1900/2100 MHz GSM/GPRS/EDGE: 850/900/1800/1900 MHz <sup>2</sup>
Digital / Analog Input / Output	DI x 4, DO x 2, AI x 4
Active DO	12V, 100mA (connection with relay, sensor)
<b>Communication Protocol</b>	
Ethernet	Modbus-TCP, IEC 60870-5-104
RS485	Modbus-RTU, IEC 60870-5-103 (standard), DL / T645
<b>Interaction</b>	
LED	LED Indicator x 3 – RUN, ALM, 4G
WEB	Embedded Web
USB	USB 2.0 x 1
APP	FusionSolar APP Communicated by WLAN for Commissioning
<b>Environment</b>	
Operating Temperature Range	-40°C ~ 60°C (-40°F ~ 140°F)
Storage Temperature	-40°C ~ 70°C (-40°F ~ 158°F)
Relative Humidity (Non-condensing)	5% ~ 95%
Max. Operating Altitude	4,000 m (13,123 ft.)
<b>Electrical</b>	
AC Power Supply	100 V ~ 240 V, 50 Hz / 60 Hz
DC Power Supply	12V / 24 V
Power Consumption	Typical 8 W, Max. 15 W
<b>Mechanical</b>	
Dimensions (W x H x D)	225 x 160 x 44 mm (8.9 x 6.3 x 1.7 inch, without mounting ears and antenna)
Weight	2 kg (4.4 lb.)
Protection Degree	IP20
Installation Options	Wall Mounting, DIN Rail Mounting, Tabletop Mounting

\*1: When putting inside metal box, extended antenna will be needed.

\*2: For recommended carriers list and details on supported frequencies, please contact local distributors.

\*3: Devices refer to: Inverter, meter, weather station devices and so on.





## Smart

Smart zero export control design



## Simple

Easy to install on site



## Reliable

Safety by lightning protection module

Technical Specification	SmartLogger3000A00GL
<b>Device Management</b>	
Max. Number of Manageable Devices <sup>2</sup>	80
<b>Communication Interface</b>	
WAN	WAN x 1, 10 / 100 / 1000 Mbps
LAN	LAN x 1, 10 / 100 / 1000 Mbps
RS485	COM x 3, 1200 / 2400 / 4800 / 9600 / 19200 / 115200 bps, 1000 m
Digital / Analog Input / Output	DI x 4, DO x 2, AI x 4
Active DO	12V, 100mA (connection with relay, sensor)
<b>Communication Protocol</b>	
Ethernet	Modbus-TCP, IEC 60870-5-104
RS485	Modbus-RTU, IEC 60870-5-103 (standard), DL / T645
<b>Interaction</b>	
LED	LED Indicator x 3 – RUN, ALM, 4G <sup>1</sup>
WEB	Embedded Web
USB	USB 2.0 x 1
APP	FusionSolar APP Communicated by WLAN for Commissioning
<b>Environment</b>	
Operating Temperature Range	-40°C ~ 60°C (-40°F ~ 140°F)
Storage Temperature	-40°C ~ 70°C (-40°F ~ 158°F)
Relative Humidity (Non-condensing)	5% ~ 95%
Max. Operating Altitude	4,000 m (13,123 ft.)
<b>Electrical</b>	
AC Power Supply	100 V ~ 240 V, 50 Hz / 60 Hz
DC Power Supply	12V / 24 V
Power Consumption	Typical 8 W, Max. 15 W
<b>Mechanical</b>	
Dimensions (W x H x D)	225 x 160 x 44 mm (8.9 x 6.3 x 1.7 inch, without mounting ears and antenna)
Weight	2 kg (4.4 lb.)
Protection Degree	IP20
Installation Options	Wall Mounting, DIN Rail Mounting, Tabletop Mounting

\*1: 4G is not available in this model.

\*2: Devices refer to: Inverter, meter, weather station devices and so on.

## Solar Panel

Brand : LONGI

Model : LR4-72HPH-450M/LR5-72HPH-540M

# Hi-MO **4m**

## LR4-72HPH 430~460M

- Suitable for ground power plants and distributed projects
- Advanced module technology delivers superior module efficiency
  - M6 Gallium-doped Wafer
  - 9-busbar Half-cut Cell
- Excellent outdoor power generation performance
- High module quality ensures long-term reliability

**12**

12-year Warranty for  
Materials and Processing

**25**

25-year Warranty for Extra  
Linear Power Output

### Complete System and Product Certifications

IEC 61215, IEC 61730, UL 61730

ISO 9001:2008: ISO Quality Management System

ISO 14001:2004: ISO Environment Management System

TS62941: Guideline for module design qualification and type approval

OHSAS 18001: 2007 Occupational Health and Safety

# LONGI



**21.2%**  
MAX MODULE  
EFFICIENCY

**0~+5W**  
POWER  
TOLERANCE

**<2%**  
FIRST YEAR  
POWER DEGRADATION

**0.55%**  
YEAR 2-25  
POWER DEGRADATION

**HALF-CELL**  
Lower operating temperature

## Additional Value

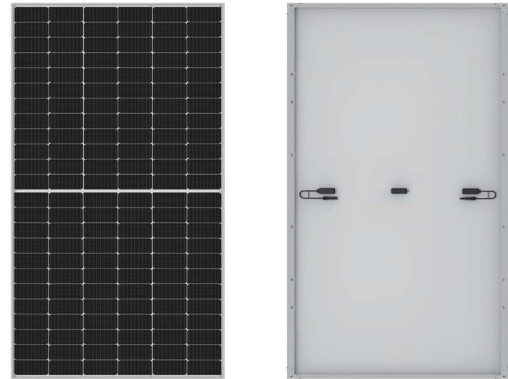
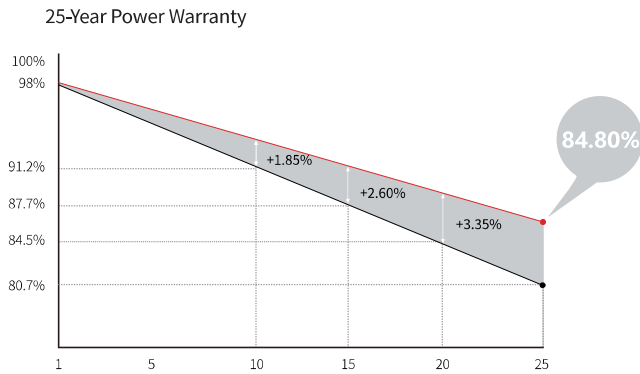

## Mechanical Parameters

Cell Orientation	144 (6×24)
Junction Box	IP68, three diodes
Output Cable	4mm <sup>2</sup> , 1400mm length can be customized
Connector	EVO2
Glass	Single glass, 3.2mm coated tempered glass
Frame	Anodized aluminum alloy frame
Weight	23.5kg
Dimension	2094×1038×35mm
Packaging	30pcs per pallet / 150pcs per 20' GP / 660pcs per 40' HC

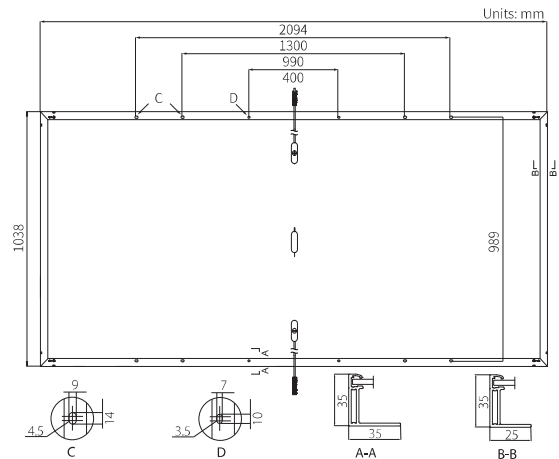

## Electrical Characteristics STC : AM1.5 1000W/m<sup>2</sup> 25°C Test uncertainty for Pmax: ±3%

	430	435	440	445	450	455	460
Power Class	430	435	440	445	450	455	460
Maximum Power (Pmax/W)	430	435	440	445	450	455	460
Open Circuit Voltage (Voc/V)	48.5	48.7	48.9	49.1	49.3	49.5	49.7
Short Circuit Current (Isc/A)	11.31	11.39	11.46	11.53	11.60	11.66	11.73
Voltage at Maximum Power (Vmp/V)	40.7	40.9	41.1	41.3	41.5	41.7	41.9
Current at Maximum Power (Imp/A)	10.57	10.64	10.71	10.78	10.85	10.92	10.98
Module Efficiency(%)	19.8	20.0	20.2	20.5	20.7	20.9	21.2

## Operating Parameters

Operational Temperature	-40°C ~ +85°C
Power Output Tolerance	0 ~ +5 W
Voc and Isc Tolerance	±3%
Maximum System Voltage	DC1500V (IEC/UL)
Maximum Series Fuse Rating	20A
Nominal Operating Cell Temperature	45±2°C
Protection Class	Class II
Fire Rating	UL type 1 or 2

## Mechanical Loading

Front Side Maximum Static Loading	5400Pa
Rear Side Maximum Static Loading	2400Pa
Hailstone Test	25mm Hailstone at the speed of 23m/s

## Temperature Ratings (STC)

Temperature Coefficient of Isc	+0.048%/°C
Temperature Coefficient of Voc	-0.270%/°C
Temperature Coefficient of Pmax	-0.350%/°C

# LR5-72HPH 525~545M

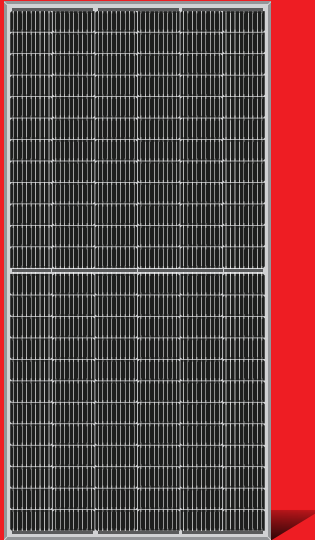

**High Efficiency  
Low LID Mono PERC with  
Half-cut Technology**

12-year Warranty for Materials and Processing;  
25-year Warranty for Extra Linear Power Output

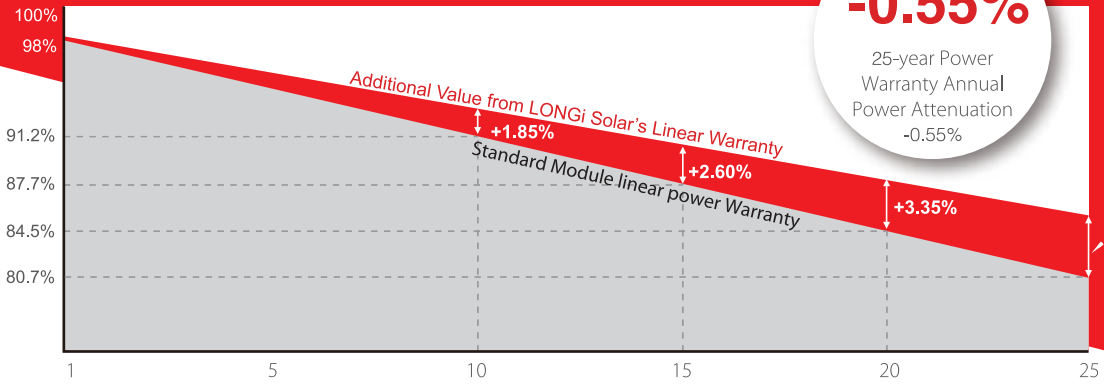

**-0.55%**  
25-year Power  
Warranty Annual  
Power Attenuation  
-0.55%

**+4.10%**

### Complete System and Product Certifications

- IEC 61215, IEC 61730, UL 61730
- ISO 9001:2008: ISO Quality Management System
- ISO 14001:2004: ISO Environment Management System
- TS62941: Guideline for module design qualification and type approval
- OHSAS 18001: 2007 Occupational Health and Safety



\* Specifications subject to technical changes and tests.  
LONGi Solar reserves the right of interpretation.

**Positive power tolerance** (0 ~ +5W) guaranteed

**High module conversion efficiency** (up to 21.3%)

**Slower power degradation** enabled by Low LID Mono PERC technology: first year <2%, 0.55% year 2-25

**Solid PID resistance** ensured by solar cell process optimization and careful module BOM selection

**Reduced resistive loss** with lower operating current

**Higher energy yield** with lower operating temperature

**Reduced hot spot risk** with optimized electrical design and lower operating current



Room 801, Tower 3, Lujiazui Financial Plaza, No.826 Century Avenue, Pudong Shanghai, 200120, China  
Tel: +86-21-80162606 E-mail: module@longi-silicon.com Facebook: www.facebook.com/LONGi Solar

Note: Due to continuous technical innovation, R&D and improvement, technical data above mentioned may be of modification accordingly. LONGi have the sole right to make such modification at anytime without further notice; Demanding party shall request for the latest datasheet for such as contract need, and make it a consisting and binding part of lawful documentation duly signed by both parties.

# LR5-72HPH 525~545M

## Design (mm)

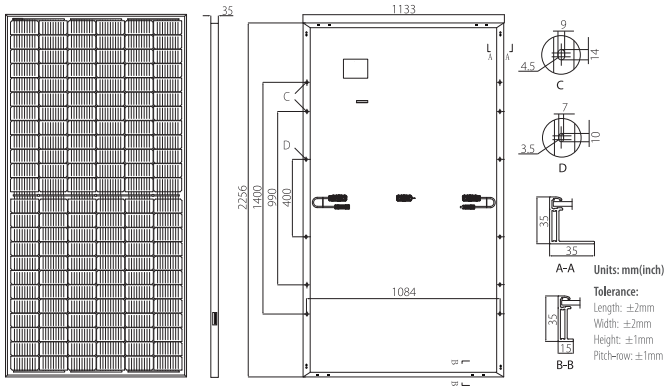

## Mechanical Parameters

Cell Orientation: 144 (6×24)  
Junction Box: IP68, three diodes  
Output Cable: 4mm<sup>2</sup>, 300mm in length,  
length can be customized  
Glass: Single glass  
3.2mm coated tempered glass  
Frame: Anodized aluminum alloy frame  
Weight: 27.2kg  
Dimension: 2256×1133×35mm  
Packaging: 31pcs per pallet  
155pcs per 20'GP  
620pcs per 40'HC

## Operating Parameters

Operational Temperature: -40°C ~ +85°C  
Power Output Tolerance: 0 ~ +5 W  
Voc and Isc Tolerance: ±3%  
Maximum System Voltage: DC1500V (IEC/UL)  
Maximum Series Fuse Rating: 25A  
Nominal Operating Cell Temperature: 45±2°C  
Safety Protection Class: Class II  
Fire Rating: UL type 1 or 2

## Electrical Characteristics

Test uncertainty for Pmax: ±3%

Model Number	LR5-72HPH-525M		LR5-72HPH-530M		LR5-72HPH-535M		LR5-72HPH-540M		LR5-72HPH-545M	
	STC	NOCT	STC	NOCT	STC	NOCT	STC	NOCT	STC	NOCT
Testing Condition										
Maximum Power (Pmax/W)	525	392.1	530	395.8	535	399.5	540	403.3	545	407.0
Open Circuit Voltage (Voc/V)	49.05	45.98	49.20	46.12	49.35	46.26	49.50	46.41	49.65	46.55
Short Circuit Current (Isc/A)	13.65	11.04	13.71	11.09	13.78	11.15	13.85	11.20	13.92	11.25
Voltage at Maximum Power (Vmp/V)	41.20	38.36	41.35	38.50	41.50	38.64	41.65	38.78	41.80	38.92
Current at Maximum Power (Imp/A)	12.75	10.23	12.82	10.28	12.90	10.34	12.97	10.40	13.04	10.46
Module Efficiency(%)	20.5		20.7		20.9		21.1		21.3	

STC (Standard Testing Conditions): Irradiance 1000W/m<sup>2</sup>, Cell Temperature 25°C, Spectra at AM1.5

NOCT (Nominal Operating Cell Temperature): Irradiance 800W/m<sup>2</sup>, Ambient Temperature 20°C, Spectra at AM1.5, Wind at 1m/s

## Temperature Ratings (STC)

Temperature Coefficient of Isc	+0.048%/°C
Temperature Coefficient of Voc	-0.270%/°C
Temperature Coefficient of Pmax	-0.350%/°C

## Mechanical Loading

Front Side Maximum Static Loading	5400Pa
Rear Side Maximum Static Loading	2400Pa
Hailstone Test	25mm Hailstone at the speed of 23m/s

## I-V Curve

Current-Voltage Curve (LR5-72HPH-530M)

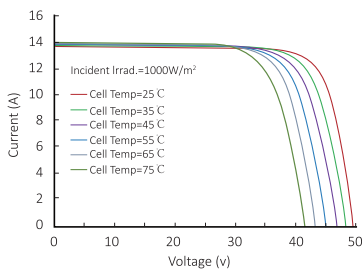

Power-Voltage Curve (LR5-72HPH-530M)

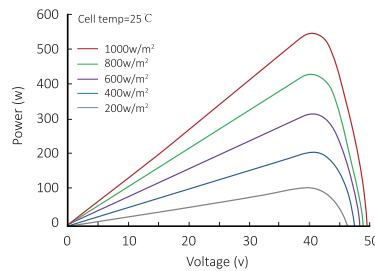

Current-Voltage Curve (LR5-72HPH-530M)

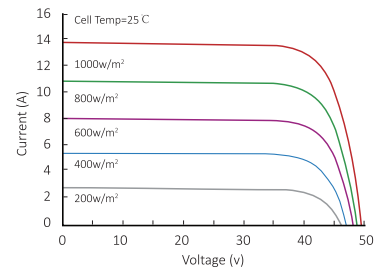

# LONGI

Room 801, Tower 3, Lujiazui Financial Plaza, No.826 Century Avenue, Pudong Shanghai, 200120, China  
Tel: +86-21-80162606 E-mail: module@longi-silicon.com Facebook: www.facebook.com/LONGI Solar

Note: Due to continuous technical innovation, R&D and improvement, technical data above mentioned may be of modification accordingly. LONGI have the sole right to make such modification at anytime without further notice; Demanding party shall request for the latest datasheet for such as contract need, and make it a consisting and binding part of lawful documentation duly signed by both parties.

## PV Cable

Brand : LINK

Model : CB-1040X



# SOLAR CABLE

## CATALOG 2020-2021





# SOLAR CABLE

## (Photovoltaic Cable)

### STANDARD

- EN 50618:2014
- IEC 62930:2017
- EN 60288, Class 5
- DIN VDE 0295 Class 5
- TÜV Approvals
- RoHs compliant

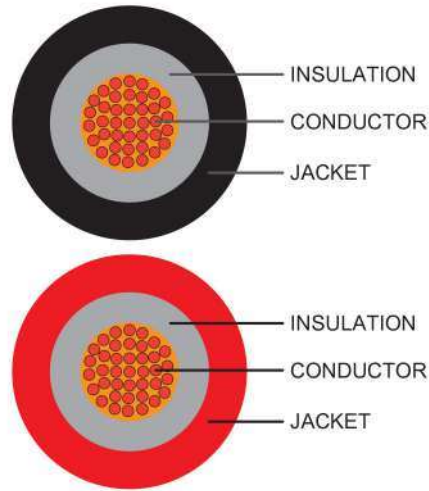
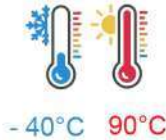

### ELECTRICAL CHARACTERISTIC

Nominal Voltage $U_0/U$	AC 1000/1000V, DC 1500/1500V
Max. DC voltage	1800V (conductor-conductor, non-earth system, circuit not under load)
AC Test Voltage	6.5 KV
DC Test Voltage	15 KV
Min. Surface resistance of sheath	$10^9 \Omega$
Electrical tests	according EN50618:2014

### TEMPERATURE

Max. temperature at conductor	-40°C to + 120°C
Temperature Range	-40°C to + 90°C

### CABLE CONSTRUCTION

Conductor Material	Fine wire stranded tinned copper according EN 60288 Class 5
Insulation Material	Halogen free, Copolymer Electron beam cross-linked polyethylene (XLPE)
Jacket Material	Halogen free, Copolymer Electron beam cross-linked polyethylene (XLPE) with FR-LSZH
Jacket Color	Red or Black

### TECHINCAL SPECIFICATION

Size (mm <sup>2</sup> )	Conductor Diameter (N/mm)	Insulation Thickness (mm)	Insulation Diameter (mm)	Jacket Thickness (mm)	Jacket Diameter (mm)	Conductor Resistance at 20°C (Ω/km)	Insulation Resistance at 20°C (MΩ/km)	Rated Current at 60°C (A)
2.5	50/0.25	0.80	3.65±0.2	0.80	5.80±0.3	≤ 8.21	≥ 690	41
4	56/0.30	0.80	4.20±0.2	0.80	6.05±0.3	≤ 4.85	≥ 580	55
6	84/0.30	0.80	4.90±0.2	0.80	6.50±0.3	≤ 3.10	≥ 500	70
10	84/0.4	0.80	5.75±0.2	0.80	8.66±0.3	≤ 1.95	≥ 420	98
16	126/0.4	0.80	7.55±0.2	0.90	10.10±0.3	≤ 1.24	≥ 340	132

### ORDER INFORMATION

Part Number	Description	Length	Package
CB-1025X	Solar Cable, H1Z2Z2-K, (1.5/1.5KV DC), 1x2.5 mm <sup>2</sup> , (Black or Red)	100/1000 m	Box./Roll.
CB-1040X	Solar Cable, H1Z2Z2-K, (1.5/1.5KV DC), 1x4 mm <sup>2</sup> , (Black or Red)	100/1000 m	Box./Roll.
CB-1060X	Solar Cable, H1Z2Z2-K, (1.5/1.5KV DC), 1x6 mm <sup>2</sup> , (Black or Red)	100/1000 m	Box./Roll.
CB-1100X	Solar Cable, H1Z2Z2-K, (1.5/1.5KV DC), 1x10 mm <sup>2</sup> , (Black or Red)	100/1000 m	Box./Roll.
CB-1160X	Solar Cable, H1Z2Z2-K, (1.5/1.5KV DC), 1x16 mm <sup>2</sup> , (Black or Red)	100/1000 m	Box./Roll.

X=Color : B (Black) , R(Red)

Add "-1" at the end of the P/N = 100 m / Box.

## IEC-01 Cable Cable

Brand : BCC

Model : 450/750V 90 ° C 60227 IEC-01

# 450/750 V 70°C 60227 IEC 01 (THW)

SINGLE-CORE NON-SHEATHED CABLE WITH RIGID CONDUCTOR

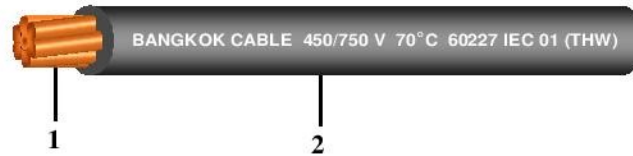

## Construction

1. Conductor : Solid or circular stranded annealed copper
2. Insulation : Polyvinyl chloride (PVC)  
Black, Light Blue, Brown, Grey, Green/Yellow  
or other colours

## Reference Standard :

TIS 11 Part 3-2553



## Classification

- Maximum conductor temperature : 70°C  
Rated voltage : 450/750 V  
AC test voltage : 2,500 V

## Application

- Use for general purpose
- For installation in raceway and shall be protected water into raceway
- Do not install in duct in ground or direct burial in ground

Products code	Conductor			Thickness of insulation mm	Overall diameter		Insulation resistance at 70°C MΩ.km (Min.)	Current rating in free air A	Cable weight kg/km (Approx.)	Standard length m
	Cross-sectional area mm <sup>2</sup>	No. of wires (Min.)	Diameter mm (Approx.)		Lower limit mm	Upper limit mm				
C6KY013V1012	1.5	1	1.36	0.7	2.6	3.2	0.011	21	21	100/C
C6KY013V4012	1.5	7	1.53	0.7	2.7	3.3	0.010	21	22	100/C
C6KY014V1012	2.5	1	1.75	0.8	3.2	3.9	0.010	29	33	100/C
C6KY014V4012	2.5	7	1.98	0.8	3.3	4.0	0.009	29	34	100/C
C6KY015V1012	4	1	2.21	0.8	3.6	4.4	0.0085	37	48	100/C
C6KY015V2012	4	7	2.49	0.8	3.8	4.6	0.0077	37	50	100/C
C6KY016V1012	6	1	2.70	0.8	4.1	5.0	0.0070	48	68	100/C
C6KY016V2012	6	7	3.09	0.8	4.3	5.2	0.0065	48	72	100/C
C6KY017V1012	10	1	3.50	1.0	5.3	6.4	0.0070	67	110	100/C
C6KY017V2012	10	7	3.99	1.0	5.6	6.7	0.0065	67	120	100/C
C6KY018V2012	16	7	5.01	1.0	6.4	7.8	0.0050	92	180	100/C
C6KY019V2012	25	7	6.30	1.2	8.1	9.7	0.0050	127	280	100/C
C6KY010W2012	35	7	7.55	1.2	9.0	10.9	0.0043	157	380	100/C
C6KY011W2011	50	19	8.75	1.4	10.6	12.8	0.0043	191	510	500/D
C6KY012W2011	70	19	10.50	1.4	12.1	14.6	0.0035	244	720	500/D
C6KY013W2011	95	19	12.35	1.6	14.1	17.1	0.0035	297	990	500/D
C6KY014W2011	120	37	13.93	1.6	15.6	18.8	0.0032	345	1,220	500/D
C6KY015W2011	150	37	15.47	1.8	17.3	20.9	0.0032	397	1,510	500/D
C6KY016W2011	185	37	17.29	2.0	19.3	23.3	0.0032	453	1,880	500/D
C6KY017W2011	240	37	19.89	2.2	22.0	26.6	0.0032	535	2,470	500/D
C6KY018W2011	300	61	22.23	2.4	24.5	29.6	0.0030	617	3,080	500/D
C6KY019W2011	400	61	25.20	2.6	27.5	33.2	0.0028	741	3,930	300/D

C = Packing in coil

D = Packing in drum

## DC Panel Board

Brand : LOCAL

Model : DC Panel Board PV-8String



## AC Panel Board

Brand : LOCAL

Model : AC Panel Board 60kW



